

DETAIL D
SCALE 2:1

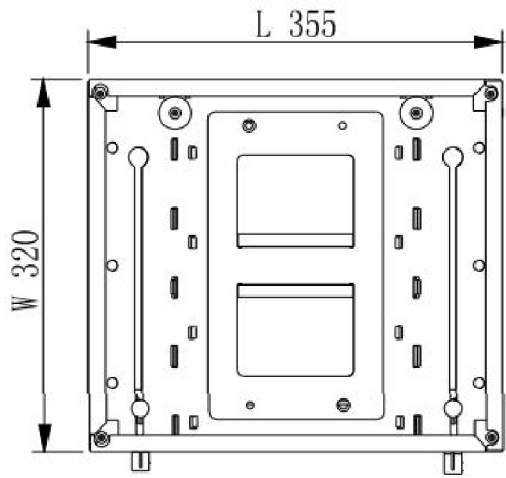

Model	external size (mm)			Ref. position (mm)		pitch (mm)	Slot width (mm)	Groove depth (mm)
	L	W	H	A	B			
109-106	355	320	563	34	34	10	5	3.5
specification for pcb size	355 (without stopper bar) *(50-250)mm							
adjustable width (AJ)	50-250mm							



+44 (0)1202 588900 | WWW.Grovesales.co.uk | Sales@grovesales.co.uk

Grove Sales Limited, Unit 3 Beaver Industrial Estate, 8 Airfield Road, Christchurch, Dorset, BH23 3TG