



A WORLD LEADER IN FUME
EXTRACTION TECHNOLOGY

Supplied by
Grove Sales
Quality Products - Reliable Service - Est 1990

FumeCAB 1000 iQ

ELECTRONICS, PHARMACEUTICAL & MEDICAL

Last Updated on 02.02.2022



The complete cabinet fume extraction solution for a broad range of applications.

Partial enclosures are becoming the recommended extraction option for a variety of applications. Government bodies, including the HSE are now making direct reference through guidance documentation such as the HSG258 to their use.

The FumeCAB 1000 iQ integrated filtration system has been designed to comply with the latest regulations. It provides users with an extra depth of working space for taller applications.

BOFA's Intelligent Operating System (iQ) and ultra-bright slimline energy-saving LED lights come as standard making this system an ideal choice of fume extraction for a wide variety of applications.

More information about the [Intelligent Operating System \(iQ\)](#).

Technology



Intelligent
Operating System
(iQ)



HEPA filter



Automatic flow
control (AFC)
technology



Reverse flow air
(RFA) technology



Advanced carbon
filter (ACF)
technology



Patented
technology



ProTECT service
plan



SureCHECK
quality standard

Key features of the FumeCAB 1000 iQ

Certified to BS 7989:2001 recirculatory filtration fume cabinet specification Standard

Reverse flow filter technology Standard

Energy saving ultra-bright slim line LED lighting Standard

Combined HEPA / gas filter incorporating ACF technology Standard

Ensures operational compliance with HSG258 guidelines Standard

Automatic flow control system Standard

Twin coated anti UV / anti splash protective polycarbonate visor Standard

Filters with long life and low replacement cost Standard

Contact BOFA at <https://bofainternational.com/en/contact/>
<https://bofainternational.com/en/portal/datasheets/fumecab-1000-iq/>



Approvals: REACH and RoHS. See individual product technical data for specific accreditations

Real time airflow reading
Standard

High contrast display
Standard

Remote diagnostics via USB
Standard

Side entry blind grommets for equipment access
Standard

Interfacing
Optional

Stand
Optional

Independent filter condition monitoring, display and warnings
Standard

'Run safe' operation
Standard

Large working area
Standard

VOC gas sensor (Volatile Organic Compound)
Optional

UV lighting
Optional

Optional filter medias
Optional

Technical specification

1. iQ display

2. On / off switch

3. Filter compartment hinges

4. Cable entry grommet

5. Transparent visor

6. Hinges

7. Mains inlet

8. LED lighting

9. Exhaust

10. Cooling air inlet

11. Standby button

12. UV lighting (optional)



Left Side / Internal work area

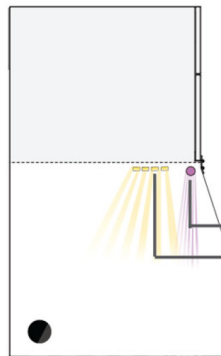

Back

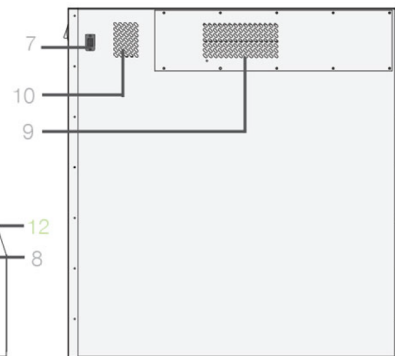

Internal work area and optional stand





13. Stand (optional)

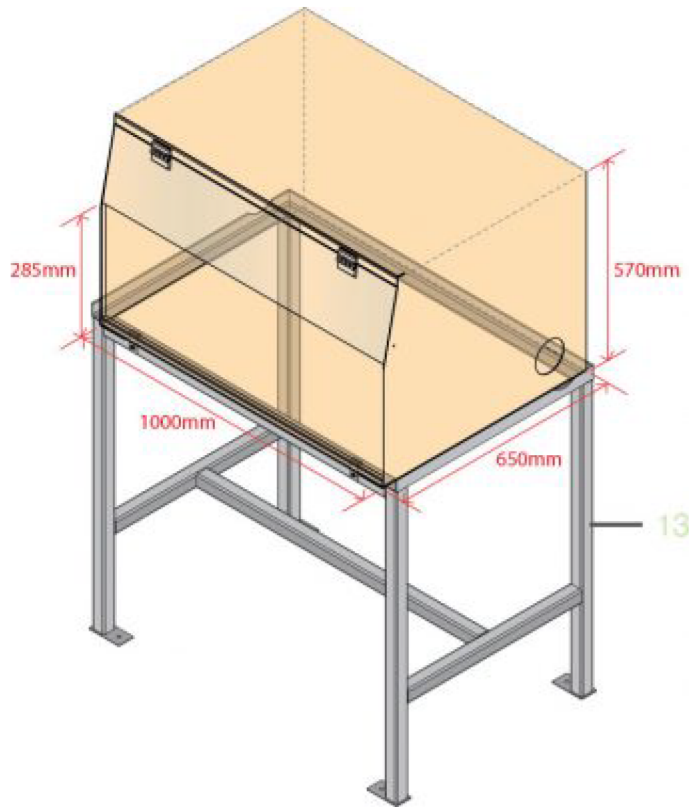

Supplied by
Grove Sales
Quality Products - Reliable Service - Est 1990



Airflow through filters

-  Chemical filter
-  HEPA filter
-  Clean air
-  Contaminated air

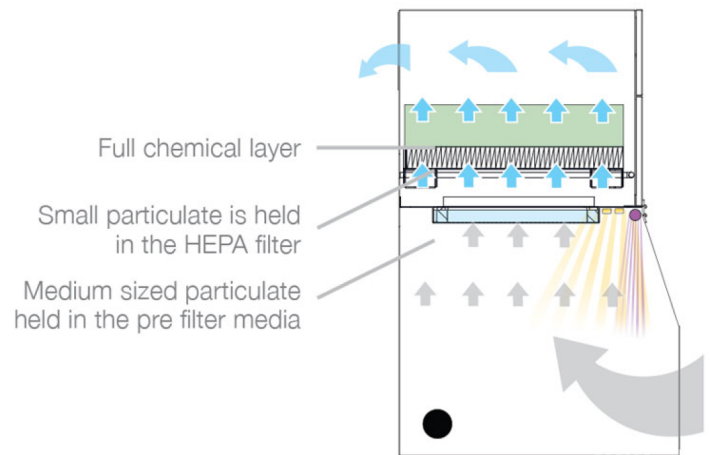

Technical data

	EU	US
Dimensions (HxWxD)	943 x 1029 x 669mm	37.13 x 40.51 x 26.34"
Opening dimensions (HxWxD)	285 x 1000 x 650mm	11.2 x 39.4 x 25.6"
Cabinet construction	Powder coated mild steel	Powder coated mild steel
Face velocity	0.4m/s	78.7ft/min
Max face velocity	0.6m/s	118ft/min
Electrical data	230v 50/60Hz Full load current: 6 amps	115v 50/60Hz Full load current: 10 amps
Noise level	< 60dBA (At typical operating speed)	< 60dBA (At typical operating speed)

Technical data

Weight	120kg	264lbs
Exhaust outlet (optional)	125mm	125mm
Approvals	UKCA and CE	UKCA and CE

Pre-filter specifications

Filter media construction	Filter pad
Filter housing	Cardboard
Filter efficiency	99% @ 0.3 microns

Combined HEPA / gas filter specifications

HEPA filter media	Borosilicate
HEPA media construction	Pleated with glue bead spacers
Filter housing	Zintec mild steel
Treated activated carbon	17kgs (37.4 lbs)
Filter efficiency	99.997% @ 0.3 microns

Optional stand specifications

Dimensions (HxWxD)	943 x 1029 x 669mm / 37.1 x 40.5 x 26.3"
Stand construction	Powder coated mild steel

Unit part numbers

Model	Voltage	Part no.
FumeCAB 1000 iQ Powder coated	230V	E2242A
FumeCAB 1000 iQ Powder coated	115V	E2241A

Replacement filter part numbers

Model	Part no.
Pre-filter	A1030249
Combined filter	A0130250

Other languages

FumeCAB 1000 iQ
[French](#)

Datasheet correct at time of publishing.

Where applicable, the carbon used in BOFA units is capable of removing a wide range of VOCs, however it is the responsibility of the user

to ensure the carbon is suitable for their application. For specific applications, please contact us for details.

Important Notice: Many factors beyond the control of BOFA can affect the use and performance of BOFA products in a particular application, including the conditions under which the product is used. Since these factors are uniquely within the user's knowledge and control, it is essential the user evaluate the products to determine whether the product is fit for the particular purpose and suitable for the user's application. All products, product specifications, availability and data are subject to change without notice, and may vary by region or country.

Think before you print! Please consider the environment before printing this document.

